

DEUS® V6



WS4 MASTER



GB

MADE IN FRANCE

OC00BC

USER'S MANUAL



*optional

TABLE OF CONTENTS

TECHNICAL INTRODUCTION — Page 02	
	POWER SUPPLY - BATTERIES
LIST OF PARTS - ASSEMBLY — Page 03	Battery status — Page 18
	Battery life — Page 18
	Charging time and charging progress — Page 18
USE	USB charger — Page 19
Wireless headphones — Page 05	Battery durability — Page 19
Factory programs, Description — Page 06	Replacement — Page 20
Starting up — Page 07	Precautions — Page 20
MENU	EXPERT
Discrimination — Page 08	Multi-Tones — Page 21
Discrimination IAR (Gold Field) — Page 09	Pitch — Page 21
Sensitivity — Page 09	Full Tones — Page 21
Frequency — Page 09	TX Power — Page 21
Iron Level — Page 10	Frequency shift — Page 22
Reactivity — Page 10	
Sound Volume — Page 12	
Audio Response — Page 12	
	PRACTICAL INFORMATION — Page 24
GROUND	PRECAUTIONS FOR USE — Page 25
General — Page 12	TROUBLESHOOTING AND SOLUTIONS — Page 26
Manual Mode — Page 13	SPECIFICATIONS — Page 27
Pumping Mode — Page 13	ACCESSORIES — Page 28
Prog.10 Gold Field — Page 14	SPARE PARTS — Page 29
Tracking Mode — Page 14	FACTORY PROGRAMS — Page 30
	YOUR SETTINGS — Page 32
OPTION	RECOMMENDATIONS / LAW — Page 34
Replacement of the backphone — Page 15	DECLARATION OF CONFORMITY — Page 34
Pairing WSAudio — Page 15	WARRANTY - AIR TRANSPORT — Page 36
Pairing / Remove PIN POINTER — Page 15	
Programs — Page 16	
Save or delete a program — Page 16	
Coils — Page 16	
Pairing with a new coil — Page 17	
Delete coil — Page 17	
Smartphone app - GO TERRAIN — Page 17	

CONGRATULATIONS ON THE PURCHASE OF YOUR XP METAL DETECTOR AND WELCOME TO THE WORLD OF RESEARCH AND EXPLORATION!

You have invested in a high-tech metal detector capable of exceptional performance, which has been designed and developed in France. You are therefore helping our Company to further expand our research in the field of metal detecting and we thank you for your contribution.

TECHNICAL INTRODUCTION

The XP Dēus is innovative in terms of metal detector design as it offers a unique design based on three elements communicating via a digital radio link. The search coil, remote control and headphones have each been made independent through the integration of very compact, high-capacity lithium batteries.

An ultra-miniature electronic circuit, incorporated into the search coil, digitises and analyses the signals. Data is then sent to the headphones and remote control in real time via a digital radio link. With this method, the signal is processed at source and not conveyed via a wire link, which greatly improves data quality.

Incorporating components from leading-edge technologies such as scientific instrumentation has enabled us to produce a powerful, rapid, lightweight, compact and fully controllable digital detector.

Whether you are an experienced user or a beginner, the Dēus lets you decide whether or not to modify any of its settings. Powerful pre-configured factory programs enable all users to get started immediately, while expert detectorists can choose more advanced parameters via the intuitive interface.

What is described in this manual as the "Remote Control" is in fact the user interface, known as the 'control box' on conventional detectors. It enables the detector's many functions to be precisely adjusted via a graphical interface. It can also receive program updates (via internet) through its USB socket.

The Dēus is also exceptional in being able to function without the remote control, with just the coil and the wireless headphones (WS4/WS5), for an even more compact, lightweight configuration !

Like the remote control, the WS4/WS5 contain all the components needed for detection, they are a genuine control unit in themselves, but on an ultra-miniature scale and rain proof. They take over in the absence of the remote control for adjusting the detector settings. With the WS4/WS5 you can turn the Dēus on and off, change the main detection settings such as sensitivity, discrimination, ground balance, tone, frequency (from 4 to 80 kHz depending on the selected search coil), volume, etc. as well as selecting the factory programs or those previously configured with the remote control !

Performance is identical whether you are searching with or without the remote control !

Lastly, the new patented XP stem has the combined advantages of an S-shaped stem and a straight telescopic stem. It enables you to deploy or fold away the device in just a few seconds, and to change the coil in an instant. Its user-friendly design ensures comfort and convenience for the user: length adjustable by millimetre increments, improved operating angle and shaped rubber handle for a firm, controlled grip.

LIST OF PARTS (WS4 master)



The box for your Dēus metal detector (subject to version purchased) contains the following parts:

- 1 One assembled fully telescopic stem (D044Lite or D044 depending on available stock)
- 2 One WS4 module clipped on his backphone with storage case
- 3 One search coil with coil cover
- 4 One WS4 stem support
- 5 One connection cable: USB / three mini-B plugs
- 6 One WS4 Clip jack adaptor
- 7 One connection clamp for recharging the coil
- 8 One set of fastenings

ASSEMBLY



WS4 Stem Support Assembly

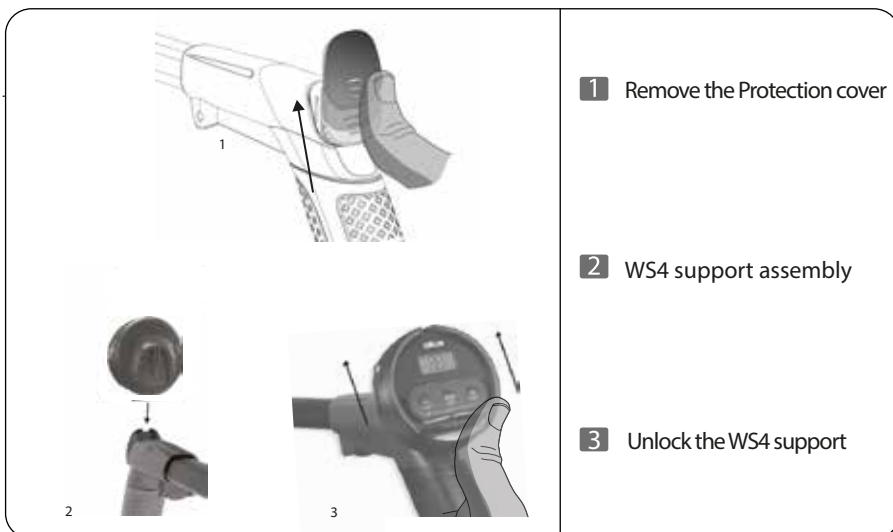

- 1 Remove the Protection cover
- 2 WS4 support assembly
- 3 Unlock the WS4 support

ASSEMBLY

COILS

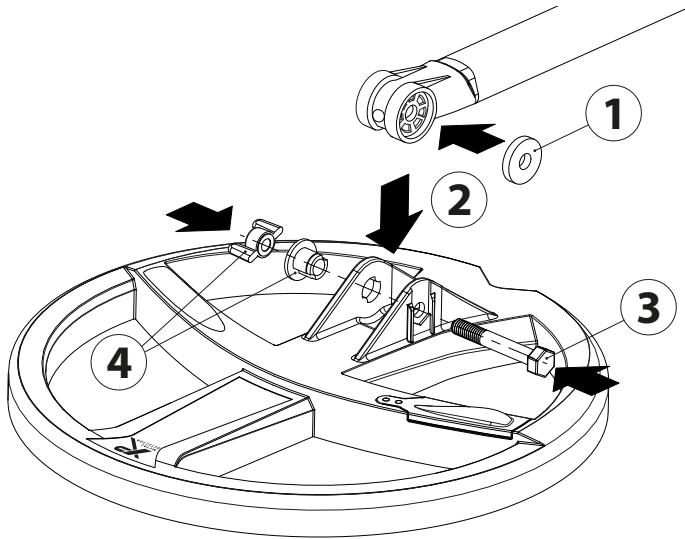

HF COILS

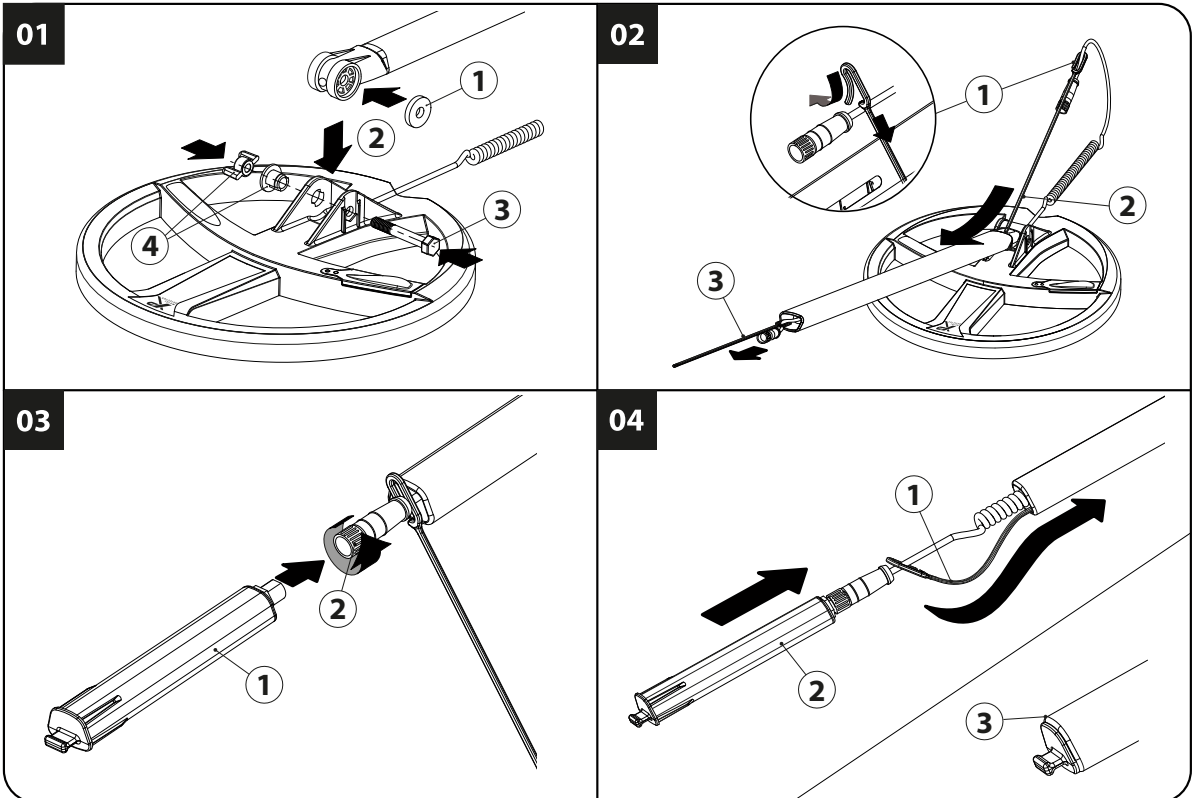

WIRELESS HEADPHONES WS4 / WS5 / WSAUDIO



WS5 The WS4 /WS5 can be a stand alone unit and connect with the coil for an extremely ergonomic and lightweight configuration.

The WS4 Module can be unclipped and mounted on the stem to make the most of the control screen, the target display and all the settings. It is then ideally supplemented by the WSA wireless headphones.



The WSAUDIO wireless headphones are the slave when the WS4 MASTER are switched on. WSAUDIO is only compatible with:

- 1/ DEUS marketed since 2018 and updated to V6.
- 2/ X35 or HF coils.
- 3/ ORX metal detectors.

DEUS - 3 CONFIGURATIONS



(820g in hand with the 22.5 cm coil)

The WS4 MASTER controls the coil, adjusts all the settings with a target ID display (TID).



(750g in hand with the 22.5 cm coil)

The WS4 / WS5 controls the coil, adjusts all the settings with a target ID display (TID).

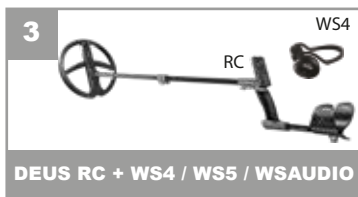

(975g in hand with 22.5cm coil)

The remote control is master and controls the coil, the functions and the settings.

WS4 / WS5 FEATURES

the setting value or the number of the factory program P1, P2, etc or the Target ID (TID)

Increase / Decrease / change Programs.

ON : Press

OFF : Press and .

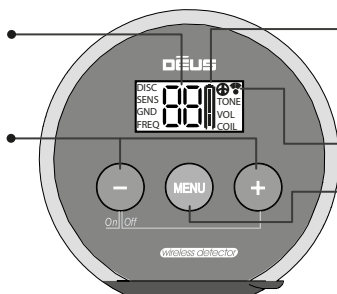

the battery charge level of the coil and the headphones alternately with

Displayed : Coil battery level
Not displayed : Headphones battery level

Radio link with the active coil

Settings :

- DISC** : Discrimination
- SENS** : Sensitivity
- GND** : Ground
- FREQ** : Frequency
- + **Expert** menus

TONE : Tones

VOL : Audio Volume

COIL : Coil Choice

Pairing : Coils / MI-6 / WSAUDIO

P1 to P10 : Programs

- 1 - BASIC ----- General use.
- 2 - GM POWER ----- Similar settings to the XP Gold Maxx Power detector, powerful and fast.
- 3 - DEUS FAST ----- More selective to small targets in iron-infested ground and deeper on mineralised ground
- 4 - PITCH ----- Responsive pitch that varies in frequency and amplitude according to the signal's strength.
- 5 - G-MAXX ----- Medium speed, particularly effective for large masses and highly conductive coins.
- 6 - DEEP ----- Pro setting for locating deep targets, with moderate discrimination and specific signal processing
- 7 - WET BEACH ----- Wet beaches, although in situ adjustments are needed for the ground effect, either by pumping or manually adjusting. (pg 13).
- 8 - DRY BEACH ----- Suitable for dry sand.
- 9 - HOT ----- HOT «The Pro setting» this is a find everything program, based on the Full Tone audio mode with a very low discrimination. Hot is a very interactive program offering excellent feedback and target information.
- 10 - GOLD FIELD ----- GOLD FIELD uses another detection method designed for searching highly mineralised ground which is often where gold nuggets are found. In these conditions, targets can be seen as ground mineralisation or ferrous objects, especially when they are deep. To go deeper in these difficult conditions, the "Gold Field" program uses a true All Metal mode that allows you to accept a zone of ground that is usually not available. Instead of rejecting all the ground values below a predefined value (as on conventional detectors), it rejects only the specific value of ground in which you are searching, which means you have to adjust precisely.

In this program certain settings are not active or are replaced by the another specific setting such as:

- The IAR discrimination (Iron Amplitude Rejection): A range of discrimination that can be applied from 0 to 5. It applies only to targets that produce strong signals – typically shallow ferrous items. It will not reject deeper targets which may come across as ferrous when they are buried in mineralised ground to ensure good targets are not rejected by mistake.

Note: The digital target display is active, this allows the operator to work in All Metal mode with a visual recognition (valid on shallow targets).

After charging your device. (pg 18)

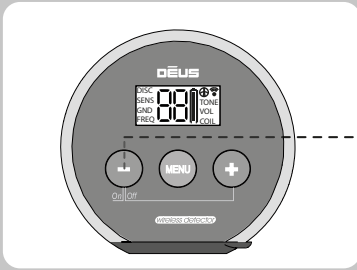

Switch on the WS4 module

(after extending stems and holding the coil
away from the ground and any metal)

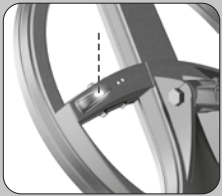



The LED on the coil gives 20 long, successive flashes to indicate that it is waking up and recalibrating.



Once recalibration is complete, the coil becomes operational and its LED flashes every second.

By default you begin by using the **1 - BASIC** factory program which is suitable for general use.

If you wish to test one of the 10 other factory programs,

simply scroll through them with  

To switch off the DÈus

Press left- and right-hand buttons simultaneously    on the WS4 module.



Configuring the main detection settings.

Press **MENU** to access the different menus. Adjust with **-** **+**

DISCRIMINATION



DISC Discrimination: -6-99 .

-- A flashing digit represents a digit after the decimal point.

Discrimination enables undesirable targets to be rejected by raising or lowering a threshold below which certain metals are differentiated. The conductivity scale (-6.4 to 99) for metal targets shown below will help you better understand the discrimination range and its limits.

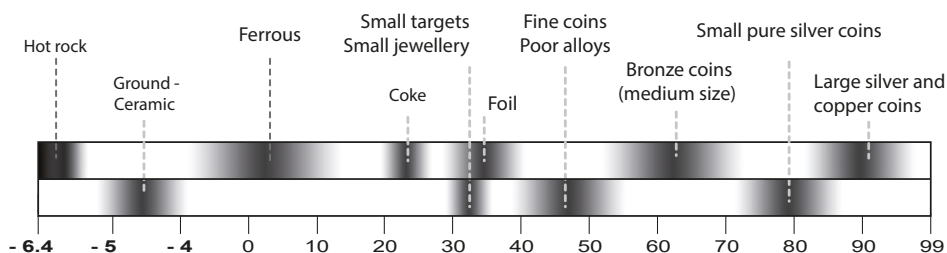

Increasing the discrimination value enables you to gradually reject any target whose conductivity is lower than the setting. For example, if you tune the discrimination level to 10, you will reject iron with a value of between -6.4 and 10. If you tune it to 40 you will also eliminate small pieces of aluminium foil whose conductivity is less than 40. If you wish to reject other rubbish with higher conductivity, such as pull tabs from aluminium drinks cans, lead shot or copper hunting cartridges (whose conductivity is 60-75), you must also be prepared to accept the elimination of certain good metals with similar conductivity.

Two alternatives involve selecting a low level of discrimination, between 5 and 10, then using either:

- 1/ The digital target display to more or less visually discriminate a target category.
- 2/ The Multi-tone mode to discriminate undesirable targets using a selected audio tone.

In both cases the decision then lies with you on whether or not to dig.

Note: Depending on the frequency setting used, a target's conductivity is perceived differently by the detector. The digital conductivity display may therefore vary depending on the frequency.

Note: The 0 to 10 range relates to the rejection of iron. To achieve greater precision in this range there is a digit after the decimal point (from 0 to 9.9).

DISCRIMINATION IAR (prog 10 GOLD FIELD)

The program N°10 GOLD FIELD uses another discrimination method, called IAR (Iron Amplitude Rejection): the range of discrimination can be applied from 0 to 5. It applies only to targets that produce strong signals – typically shallow ferrous items. It will not reject deeper targets which may come across as ferrous when they are buried in mineralised ground, to ensure good targets are not rejected by mistake. Higher discrimination values, enable the detector to reject deeper ferrous. Gold nuggets buried deep in mineralised ground can generate a similar signal to a ferrous item, so in this case it is better to reduce the level of discrimination.

SENSITIVITY



SENS Sensitivity: 0-99.

Sensitivity is often simplistically described as the setting which adjusts the device's power level. However this is incorrect. As its name indicates, it actually determines the device's sensitivity level. It reacts after receiving a signal via the receiver coil. Nevertheless, the results are somewhat similar in practice, as increasing a device's sensitivity enables it to detect the presence of more distant targets. However it must be noted that this setting has no effect on the power emitted.

The most commonly used sensitivity levels range from 70 to 90. It may be necessary to reduce the level if there is too much interference, as is often the case near overhead or buried power lines, fences, radio-relay stations, mobile telephones, computers, televisions, etc.

Do not test your device in your home as there is considerable electromagnetic and metal interference in urban environments.

FREQUENCY



FREQ Choice of frequency used.

The DēUS gives you the choice of several detection frequencies from 4 to 80 kHz depending on the selected coil. The frequencies enable you to adapt your research more closely to the characteristics of the ground and desired targets.

Here is a brief list of the most likely targets that may be detected according to the frequency:

4 kHz	Large, mainly ferrous and non-ferrous masses. Coins of sufficient conductivity and size. All other medium or relatively small targets in non-mineralised ground relatively uncontaminated by iron. Good for ferrous masses and militaria.
8 kHz	General use. Coins and large masses, militaria. Medium and small targets in low-mineralised ground.
12 to 15 kHz	General use, small coins. Coins of all sizes in medium to highly mineralised ground.
18 to 80 kHz	Small coins made from any alloy (gold, silver, copper, etc.) and very fine coins, low conductivity target, gold nuggets, lead, rings, thin metal, aluminium foil. Discriminates (distinguishes) coke more easily. Can be more unstable on non-mineralised and moist ground

IRON VOLUME



TONE EXPERT: Press  2 sec to blink "TONE" and adjust the **IRON VOLUME**.

You have the option of controlling the volume of the low-pitched tone which generally corresponds to iron. Depending on the circumstances, sometimes reducing the iron volume can make the user more aware of non ferrous targets.

On the other hand, some users prefer to make the low-pitched signals from iron more audible, as they know that some good targets at the detector's depth limit in mineralised ground can sometimes generate a low-pitched sound.

- At 0 the low-pitched tone is cut off.
- At 5 the low-pitched tone will have a sound level equivalent to other non ferrous targets.

Note : If the discrimination threshold is too low, 0 or 2 for example, most iron will generate not low but medium-pitched tones, as you will practically be in the All Metal mode. In this case, the iron level setting will have very little function.

REACTIVITY

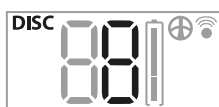

DISC EXPERT: Press  2 sec to blink "DISC" and adjust the **REACTIVITY**.

The Reactivity is a vital setting that determines the detector's performance in terms of how quickly it analyses the signal from detected objects and its ability to separate the signal response from two targets located close together. This is also known as Recovery speed.

If the soil contains a great deal of iron, hot rocks or other mineralised debris, soil penetration can be drastically reduced. In these conditions, The Dēus enables you to select a high degree of reactivity which will help you speed up the analysis of signals.

On the other hand, if the ground is "clean", it is better to reduce the Reactivity and sweep slowly, in order to make the machine more sensitive to deep masses and obtain better soil penetration.

Users familiar with the Gold Maxx Power have already experienced the advantages of the XP Reactivity (recovery speed). And even though the Dēus is a particularly fast and selective detector, you now have the option of adjusting the reactivity setting to make it even more selective!

To help you better understand the reactivity levels available, you should note that the reactivity of most detectors on the market, generally only have an equivalent to level of 1 compared to the Dēus. The Gold Maxx Power has a reactivity equivalent to level 2 of the Dēus.

Most likely finds with the recommended settings are as follows:

0	Large masses and coins, in ground uncontaminated by iron.
1	Large masses and coins, in ground with little iron contamination, and general use.
2	General use, and mineralised soils contaminated with iron.
2.5	General use, difficult soils contaminated with iron
3	Difficult soils contaminated with iron, hot rocks, etc.
4/5	Very difficult soils, highly contaminated with iron and hot rocks.

REACTIVITY

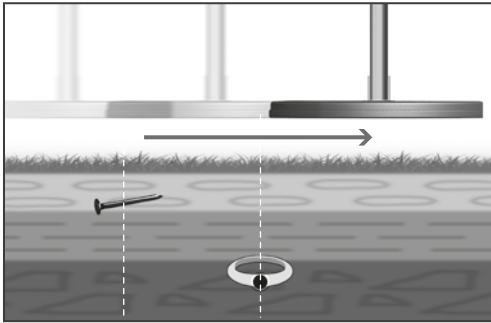

Example

Passing the coil over an iron object close to the surface then over a good metal target (ring).

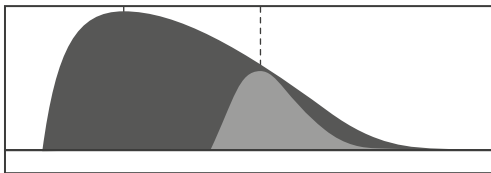

With a low Reactivity level, the iron is detected for a longer duration, to the extent that it completely hides the ring.

No sound

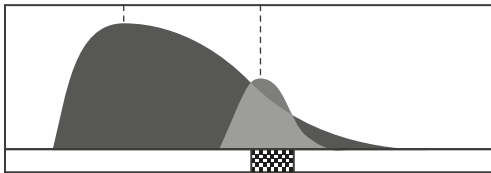

With a medium Reactivity level, you begin detecting the ring. The audio signal partially indicates the target.

Short sound

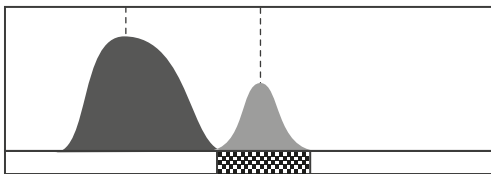

A high Reactivity level enables you to distinguish the ring completely from the iron. The audio signal fully indicates the target.

Full sound

In terms of pure performance, the greatest detection ranges are obtained with low reactivity levels. However, you will find more targets and will detect deeper on mineralised ground with medium or high reactivity levels.

For optimum performance adjust your reactivity to suit your search conditions.

Depending on the reactivity level, you will notice that the length of the audio signal varies when it passes over a target:

Low reactivity (0 to 2) = long sound



High reactivity (2.5 to 5) = short sound



Evidently the length of any false signals (the crackling of iron for example) will vary proportionately as well.

You are therefore advised not to constantly change the reactivity level, as this may interfere with your ability to distinguish good and bad sounds.

SOUND VOLUME



VOL Adjusts sound volume in headphones: 0-9.

AUDIO RESPONSE



VOL **EXPERT:** Press **MENU** 2 sec to blink "VOL" and adjust the **AUDIO RESPONSE**.

The Audio Response enables you to amplify the volume of deep targets. It gives the impression of greater power, however it does not provide any additional depth as this setting only affects the sound curve (the dynamic range of sounds). Lower Audio response levels give a good perception of depth

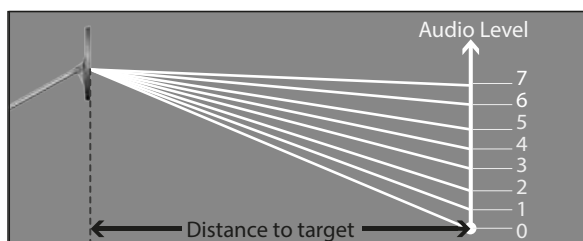

Note : By amplifying small signals you will also be amplifying small spurious false signals.

Note : By increasing the sound response you will compress the dynamic range and thus reduce the appreciation of a target's depth.

GROUND

The different levels of soil mineralisation you encounter when prospecting can sometimes affect the performance of your detector. For example, this may be due to natural magnetic mineralisation such as iron oxide, hot rocks and magnetite, or sporadic mineralisation from sites of former human settlement (also magnetic): hearths, pottery, hot rocks, slag, etc. At the seashore this may also involve mineralisation ranging from magnetic grade (black sand) to electrical conductor grade (salt water) depending on the beach or region.

If you are an experienced detectorist you may wish to optimise your searches to achieve better penetration in some of these mineralised soils.

In magnetic ground with relatively uniform mineralisation, a setting which is adjusted according to the ground effect will improve penetration by reducing the amplitude of the ground signals sent back by the receiver circuits. This 'adapted setting' involves adjusting your ground balance value to the average value of the ground being detected, while adding 1 so as not to hear the ground signals as much. The tracking and pumping modes do this automatically if the ground conditions allow it. With the Prog.10 Gold Field it is vital to set the machine exactly to the value of the ground.

General features

⚠ As the ground balance setting is the one requiring the most experience, we recommend that you read this chapter and use the different ground balance modes carefully, while acquiring your own experience of the ground. By default, remain in manual mode at level 90 for inland or dry sand. On wet beach reduce the level from 25 to 27.

Note: If the ground is not mineralised, there is no need to adjust your ground balance to a level other than 90: since the ground does not send back any significant spurious echo, the performance will be optimal even at level 90 and you will reduce interference resulting from knocks to the coil.

MANUAL MODE



GND Ground balance.

60-95: (inland ground) **0-30:** (Only with program N°7, for beach, wet zone)

You can manually adjust the ground rejection levels from 60 to 95 or from 0 to 30 (depending on used program)

Each ground rejection level from 60 to 95 receives additional units of fine adjustment to allow better ground tracking.

By reducing G.B towards 87 you will begin detecting hot rocks, and knocks to the coil may result in false signals. Even lower, between 75/85, pottery and the ground itself will begin interfering with your device.

Note: If you are inexperienced in working with ground effects, we strongly suggest that you limit yourself to a Ground Balance level of 90, which is the default setting, and is the most stable reference level recommended for inland ground. Levels lower than 90 will result in increasing instability.

Note: To improve stability on wet beach (salt water), Reduce Audio Response (0-1) / Increase Reactivity (4) / Power: Level 1 maximum. / Sensitivity: (70-85).

Note: In wet zones (salt water), it is important to sweep while keeping the coil parallel to the ground, yet not touching it.

Note: In wet zones select the Wet Beach factory programme.

PUMPING MODE



- 1 Press to reach Program (P1...), Select Program 10 (P 10) with or
- 2 Press to reach "GND".
- 3 Press while pumping the coil on the ground to grab the ground value.

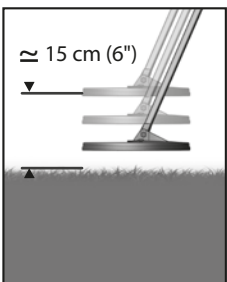

Pumping is a semi-automatic process which allows you to adjust the ground balance in a zone that you wish to search and have determined it as being an overall average soil type. Henceforth, the measured value of the ground is entered into the memory and used as the new active ground balance value.

If this value is unsuitable, or if it generates too much instability, you can repeat the process in a different zone or switch to manual mode adding several extra rejection points.

Note: In low- or non-mineralised ground, there is no need to adjust the ground balance and you are advised to remain on 90 for greater stability.

PUMPING MODE PROG 10 GOLD FIELD

The program 10 GOLD FIELD is adapted specifically to search for gold nuggets in mineralised soils or likely gold areas. These areas are difficult to prospect with conventional detectors. The reason for this being the presence of ferromagnetic metals, they hide gold nuggets. Program n°10 GOLD FIELD uses another technique different from conventional detectors which cannot achieve an accurate ground balance in such extreme conditions.

⚠ Restart the operation if the ground changes or it becomes unstable.

TRACKING MODE



GND EXPERT: Press **MEMU** 2 sec to blink "GND" to activate the **TRACKING MODE**.

In this mode, the Dēus repeatedly scans the ground and digitally filters the extracted signals to determine the mean value on a continual basis. This mode may be useful in soils with relatively uniform mineralisation, and where the mineralisation varies gradually from zone to zone, which is often the case in naturally mineralised ground. In this case, the Dēus automatically readjusts the ground balance according to the most recent value measured.

However, in ground where mineralisation is a result of human presence (ancient settlements, for example) this mode may be unsuitable due to ever changing ground conditions. Indeed, within the same sweep of just one meter, a considerable variety of ground conditions may be encountered, ranging from one extreme to the other (values between 70 and 90): hot rocks, brick, slag, pottery interspersed with soil that is neutral or characterised by diverse mineralisation. This may be to such an extent that any mean value would be meaningless. You must then determine an acceptable level of rejection for the ground based on your own experience of the site, your detection methods and the interference that you are prepared to tolerate.

Note : This mode is not available in program N°7, as the Pumping mode is more effective.

Note : Low ground balance levels also generate the clearest signals on certain irons targets that are already difficult to eliminate.

Replacement of the backphone



The electronics housing of the WS4 contains all the electronics and the lithium battery, it represents your detector's brain! (ref: D091) Fitted on a sliding support, it has the advantage of being able to disconnect from the backphone with a single click. This backphone is an inexpensive spare part that can easily be replaced by yourself (ref: D096). Available from all our resellers.

Pairing WSAUDIO to WS4 MASTER



Press **MENU** until **COIL** and **+** until you reach **IIP**, then press **+** 5 seconds. **IIP** flashing. Switch ON the WSAUDIO by holding the **-** key down for 5 seconds.

Shortcut : Press 5 seconds **MENU**

Switch ON the WSAUDIO by holding the **-** key down for 5 seconds.

Note : When paired, the WSA automatically switch OFF when you shutdown the WS4.

Remove the WSA at the WS4 MASTER



- 1 Press **MENU** until you reach **COIL**.
- 2 Press **+** to reach **IIP**, then press **-** 3 seconds.
- 3 Press **MENU**

PINPOINTER MI-6



When connected, the MI-6 pinpointer transmits its audio signal directly to the DEUS.

Pairing the WS4 MASTER at the MI-6



- 1 Press **MENU** until you reach **COIL**.
- 2 Press **+** to reach **PP**, then press **+** 3 seconds. **PP** flashing.
- 3 Turn on the MI-6 by holding the button down for 8 seconds. PP is paired.
- 4 Press **MENU**

Note : When pairing, the MI-6 automatically switches to program 7 (DEUS). This program will only work with the DEUS. Program 7 will not generate any sound or vibration.

Retune At any time, you can re-calibrate the MI-6 by pressing the button very briefly while away from any metallic source. On mineralized soil, salt water, re-calibrate it in contact with the ground. To localize detection range, re-calibrate (de-tune) near to the object.

Remove the MI-6 at the WS4 MASTER



- 1 Press until you reach **COIL**.
- 2 Press to reach **PP**, then press 3 seconds.
- 3 Press .

Note: To use the MI-6 without the DEUS, select programs 1 to 6 on the MI-6 menu. To change program: Switch MI-6 on - press the button for 5 seconds, a melody indicates that you have entered the program selection mode, press to correspond with the desired program number (eg press 2 times for program 2). After 2 seconds the melody indicates the MI-6 has returned to the search mode.

PROGRAMS

Programs P1 to P10

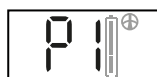

Choose one of the 10 pre-configured factory programs.



- 1 Press until you reach P1/10 screen.



- 2 Scroll with and choose the program number.

Save a modified program (P11 to P18)

Save a program after changing a few settings:

Press until you reach PROGRAMS (P1,...), then for 5 seconds press . Choose the flashing free slot with (from P11 to P18), finally save your programs by pressing .

Delete a modified program (P11 to P18)

Press until you reach PROGRAMS (P1,...), then for 5 seconds press . Choose the flashing program to delete with , and press to validate.

COILS

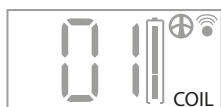

COIL Choice of coil used when several are available.

The coils are numbered according to the order in which they were entered:

01 = Original coil

02= Coil 2

PP = Pinpointer (page 15-16)

IIP = WSA headphone (page 15)

When first purchased, the D eus is only configured to operate with its original coil. If you have one or more optional coils which have already been paired (see below), you can select which one you want to use from the menu list.

COILS

Pairing the WS4 with a new Coil

When delivered, the WS4 has already been paired with the original coil, so no action is required on your part. However, if you purchase an additional coil, before using it for the first time you need to pair it with the WS4, to enable it to recognise and communicate with the WS4. You can then change coils with a simple click.

To manually pair the WS4 and a new coil, you need the serial number of the coil:

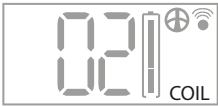

- 1 Press until you reach COIL
- 2 Choose the flashing free slot with for example 02 (01 is already assigned to the original coil).

- 3 Press for 5 seconds to switch to serial number entry mode.

- 4 With enter the first digit of the serial number then validate it with .

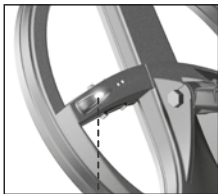

Continue in this way until you reach the sixth digit.

The new coil is now operational in this slot and should become active.



A coil's serial number is unique. The Déus cannot use a coil if the number entered does not correspond to the actual serial number printed on the coil (and sometimes appearing on the invoice as well).

Delete coil



Press until you reach COIL, then for 5 seconds press . Choose the flashing coil to delete with , and press to validate.

Smartphone application GO TERRAIN

GO TERRAIN is an application for IOS or Android smartphones, designed to optimize your Deus experience. Key features are : Geo-locate, a real time map and the ability to make an inventory of your finds.

More information on our website available coming soon.

BATTERY STATUS

The WS4 alternately displays :

The symbol and which indicates the coil's charge level.

The symbol alone which indicates its own charge level.

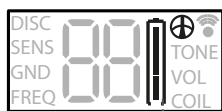

Displayed = coil's charge level.

Not displayed = WS4's charge level.

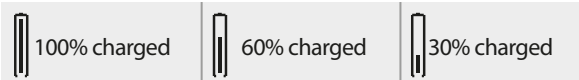

When the pinpointer is switch ON and paired with the WS4 or the WS5,

The symbol with indicates the MI-6's charge level.

The WSA indicate his charge level by one to three flashes at power ON and OFF

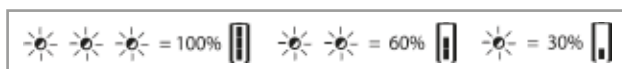

BATTERY LIFE

WS4: ~ 22 hours / **WSAUDIO:** ~ 12 hours / **COIL:** ~ 15 hours

The search coil's battery life may vary depending on the modes used. The table below shows battery life according to frequency and power selected

DEUS COIL	TX POWER 1	TX POWER 2 or 3
Frequency 25 kHz	≈ 25 hours	≈ 21 hours
Frequency 18 kHz	≈ 24 hours	≈ 21 hours
Frequency 12 kHz	≈ 22 hours	≈ 19 hours
Frequency 8 kHz	≈ 18 hours	≈ 14 hours
Frequency 4 kHz	TX Power TX NORMAL: 12 hours - TX BOOST: 6 hours	

Frequency	Battery life Elliptical HF	Battery life 22HF
14 kHz	14 hours	20 hours
30 kHz	18 hours	27 hours
55 kHz	-	28 hours
80 kHz	25 hours	-

Note: The Dêus is regulated in such a way that avoids any deterioration in performance even when the battery level is low !

CHARGING TIME

COIL/WS4/WSAUDIO: ~ 3h00.

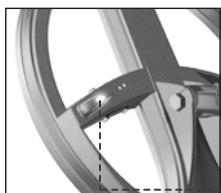

LiPo batteries (Lithium polymer) do not suffer from the 'memory effect' so you can recharge them at any time without first having to wait for them to fully discharge.

The LED on the coil and WSA is on continually when charging is underway. When charging is complete, the LED reverts to flashing intermittently.

(3 seconds ON, 3seconds OFF)

Note: The charging time varies depending of the battery condition, the HF COIL battery has more capacity, it will require a longer charge time.

USB CHARGER

(NOT PROVIDED WITH DEUS WS4 / DEUS WS5)

The search coil, WS4 and headphones are all powered by lithium polymer batteries. These miniature, high-capacity batteries can be recharged quickly. You should use an USB power adaptor, which enables all three elements to be charged simultaneously when used with the USB/3 mini-B cable supplied.



The DEUS can be charged using any standard USB 5V certified charger with a minimum capacity of 1A and 5V output. 1A 5V USB charger is enough to charge the 3 elements together (coil/remote/headphone). A computer USB output is also suitable and can charge 1 or 2 elements at a time (eg : coil + WS4).

Take care about the quality of the charger and never use unknown or unbranded cheap products. It is important to check that the charger has the correct symbols of certification :



By purchasing this product, the buyer/user agrees that he/she has read and understood the battery & charger safety precautions printed in this document, that he/she bears full responsibilities of these risks, and does not hold Xplorer, or its retailers responsible for any accidents, loss of life, injury to persons, or property damage that may occur as a result of : Incorrect use of the battery including charging with a non-approved or non-certified charger.

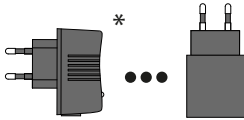

USB Charger

(Apple™, Samsung™, Sony™, Huawei™ ...)

Output 5V $\overline{=}$ 1A or +



OR

USB 2.0 port on laptop

Output 5V $\overline{=}$ 0.5A or +

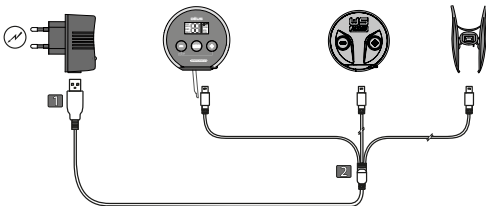

*Optional

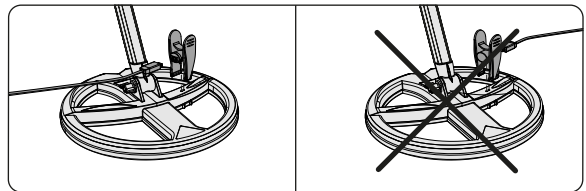

Ensure that the clamp is the right way round before connecting it to the coil. It can take up to 10 seconds for the led to activate.

LITHIUM POLYMER (LIPO) BATTERY DURABILITY

The LiPo batteries are designed to bear hundreds of charges and to last several years in your detector, thus resulting in significant savings in terms of purchase of batteries. After 300 to 400 charging cycles the battery still has 80% of its capacity, which then gradually begins to decrease over subsequent cycles. As an indication, the batteries should last for around 3 to 4 years when used on a weekly basis.

REPLACING BATTERIES

The batteries for the wireless headphones and the remote control (ref battery : GEB721944 or XP721944 - ref XP : D088M-WTUBE) are easy to replace. Unscrew the rear/lower cap of the headphones or remote control / Unclip the battery and change it. Then screw the cap.

⚠ We highly recommend that you go through an authorized XP dealer to replace any of the detectors batteries. Breakages or defects (sealing, ...) caused by changing a battery or opening any part of the detector will void the XP warranty.

BATTERY REPLACEMENT (ref battery : GEB721944 or XP721944 - ref XP : D088M-WTUBE) : The search coil battery is sealed for obvious reasons - safety and impermeability. It must be returned to our service department or an XP distributor for replacement.

- Remove the coil cover. Using a cutter, cut the battery cover along the inside groove, the battery cover is the one with the battery logo **⚠**.
- Disconnect the out-of-service battery and remove it. Lithium batteries must be recycled appropriately or returned to your retailer.
- Connect the new battery and inject silicon from the syringe onto the battery's white connector.
- Spread the adhesive from the kit on the compartment surround, insert the battery/cover assembly and stick it down. Keep the cover in place with the clamp.
- Turn the coil over and make sure it is horizontal so that the liquid silicon can complete the seal. Leave to dry for 24 hours.
- Lastly, deburr the surplus glue and reposition the coil cover.

A video explaining how to replace the battery can be viewed on the XP Internet site. The batteries carry a two-year parts and labour warranty.

PRECAUTIONS RELATING TO USE OF THE POWER ADAPTOR AND BATTERY

Acceptable ambient temperature during charging: **10° to 40°C Maximum**

Recommended storage temperature: **25°C**

Batteries

- The batteries are fitted with internal protection systems which shields them from extreme overloads and discharges. They must not be dismantled or short-circuited, which is dangerous and could destroy the protection systems, explode or cause the batteries to ignite.
- Do not leave batteries charging unnecessarily and disconnect the power adaptor when the charge cycle is complete or after 3hrs.
- If you notice any perforation, odour or other anomaly, please return the battery to the seller in a sealed plastic bag and don't try to charge again. (risk of destroying the protection systems, explosion or causing the batteries to ignite).
- Never dispose of lithium batteries with your household waste: return them to your XP seller or take them to a designated collection point.
- Do not place the batteries near heat sources and never throw them onto a fire
- Never perforate the battery cover or try and weld/solder the battery.
- Do not short-circuit the battery terminals.
- Risk off explosion if battery is incorrectly replaced. Replacing the battery with another of the incorrect type can lead to an explosion risk. Only use LiPo batteries supplied by **XP**.

Power adaptor

- The power adaptor is only designed for indoor use and should not be exposed to water or humidity.
- Always connect your power adaptor in an accessible, visible place to ensure that it can be unplugged quickly in the event of overheating or other problems.
- Do not charge close to inflammable parts.
- Do not charge the devices during a thunderstorm and unplug the power adaptor from the supply.
- Use the special XP USB charger in the recommended charging method or use a certified USB charger :



Xplorer shall not be held liable for any consequences arising from a failure to comply with the precautions for use.

This section covers the advanced settings. You should ensure that you have studied all the basic parameters before moving on to this section.

MULTI TONES

2 TONES - 3 TONES - 4 TONES - 5 TONES

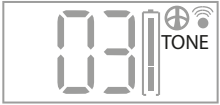

TONE Choice of number of tones: 2, 3, 4, 5 tones, Full tones, Pi (PITCH).

You can use the Multi-tones menu to sort targets into categories according to their conductivity, by assigning a specific audio tone to each category. The higher the target's conductivity, the higher the pitch of the tone. Take some time to become familiar with the 2 Tones, 3 Tones, 4 Tones, 5 Tones modes using different targets, such as an iron nail and some aluminium foil, different coins, etc. The lowest pitched tone is assigned to iron. If you do not wish to hear it, select "Iron Volume" from the menu and reduce its volume to 0.

Note: If you are in 2 Tones mode (low/medium tone) and you reduce the iron level (low-pitched tone) to 0, you then find yourself in 1 tone mode (medium), which is why there is no 1 tone mode in this scrolling menu.

PITCH

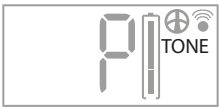

Pitch mode is completely different from the others. It does not take into account the target's conductivity: the strength of the signal generates an audio signal that varies both in volume and height (the audio frequency). This means that a more distant target will generate a low-pitched, weak sound whereas a closer target will generate a high-pitched, strong sound. Pitch mode gives a dynamic signal. It also makes the detector appear more reactive. However, it does not fundamentally affect reactivity, just the audio.

FULL TONES



The FULL TONE mode will produce a slightly different tone for each target ID value based on a sliding scale. The higher the target's conductivity, the higher the tone will be. Iron typically will produce a low tone, while silver produces a high tone. See the figure on page 9 to see where specific types of targets fall in terms of conductivity.

TX POWER



SENS **EXPERT:** Press 2 sec to blink "SENS" and adjust the **TX POWER**.

The Déus enables you to adjust the strength of the emitted electromagnetic field according to three levels (from 1 to 3).

Lower frequencies - When using frequencies between 3.7kHz to 4.4kHz, there are 2 TX power levels available, TX NORMAL (1) and TX BOOST (2 for X35 Coil).

TX BOOST offers an enhanced performance and a good choice for locating targets with a high conductivity, such as large masses, treasure and some currencies.

The XP 34 / 28cm coil will give optimum performance providing the terrain is suitable and a correct ground balance is used. The Gold Field program combined with the lower frequencies and the 34 / 28 cm coil may be a good choice for locating specific deep targets. The power increases your detector's power consumption as well as alter its stability on difficult ground. On iron-infested, mineralised ground, there is no need to use a high power setting, level 1 will be sufficient as in any case it is impossible to detect deeply in this kind of ground. It is therefore better to limit the saturation caused by iron and the ground by lowering the setting. In this way you will improve analysis and will ultimately find as many, if not more, targets since you will be better able to hear them.

Note : The HF coil also has a fixed TX Power. Lower frequencies such as 4kHz + TX BOOST mode will reduce the coil battery life to around 6 hours.

FREQUENCY SHIFT



FREQ **EXPERT:** Press **MENU** 2 sec to blink "FREQ" and adjust the **FREQUENCY SHIFT**

You can shift your operational frequency slightly to avoid occasional interference, particularly that generated by another detector nearby.

ADVICE BEFORE BEGINNING DETECTING

Metal detecting is a fascinating leisure activity that can bring you a lot of satisfaction. However, it requires a minimum of learning in order to get the most enjoyment.

Begin by familiarising yourself with your equipment and its operation on a suitable practice ground.

To do this, we recommend that you take an assortment of different objects: coins, everyday items, metal rubbish, etc. Then find a patch of ground relatively free from metal pollution and far away from any electromagnetic interference (high voltage power lines, electric fences, domestic appliances, etc.). For instance your garden would probably be one of the most unsuitable places to begin as there is too much domestic waste in the vicinity.

To ensure that the site is suitable for practising, swing the coil over the ground as if detecting. If you hear a multitude of sounds then move to another place.

Once you have found a suitable spot, arrange your objects on the ground, spacing them approximately two coil widths apart. Before placing an object, use the device to check that there is no metal already in the ground.

Then, take some time to observe your device's reactions when it passes over each target. You can then sort them according to the sound response type and try and understand what makes them similar or different. If you feel comfortable with this exercise, you can also try out some of the pre-configured settings.

OPTIMISE YOUR SEARCHING

When detecting, it is important that you sweep the coil parallel to the ground, using wide movements, as close as possible to the surface (without actually touching it). Proximity to the ground will increase the likelihood of detecting a deep target and will enable the most discreet objects to be identified more easily. You are advised to avoid knocking the coil, as although it is designed to tolerate this kind of stress, careful treatment will prolong the life of the device and guarantee you better perception of targets.

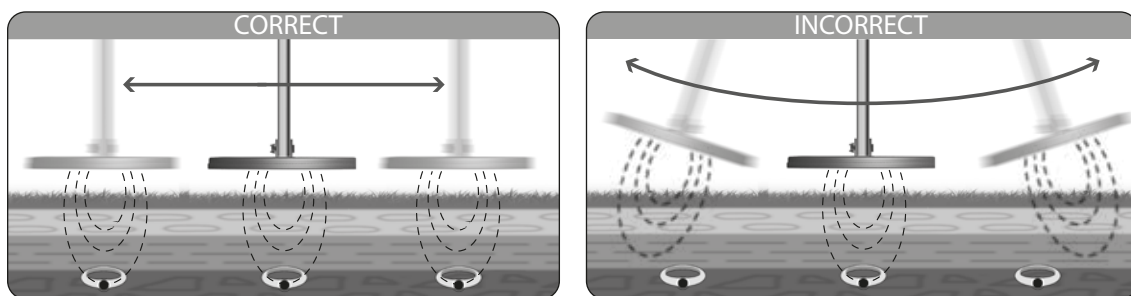

When you are detecting, you are free to choose the rate at which you move.

For example, if you prefer to cover a zone at high speed while detecting, this will certainly give you a global 'snapshot' of the site. However, it is clear that this way of detecting will also leave large areas of ground unexplored between each sweep. On the other hand, if you insist on closely scrutinising every inch of the ground, you should ensure that each sweep slightly overlaps the previous one, in order to reduce to a minimum the area that your coil has not scanned.

You should also bear in mind that you will further increase your chances of finding and identifying a target by sweeping more slowly. This particularly applies in metal-infested ground (when there are more targets to be sorted) or when you are searching for deeper targets.

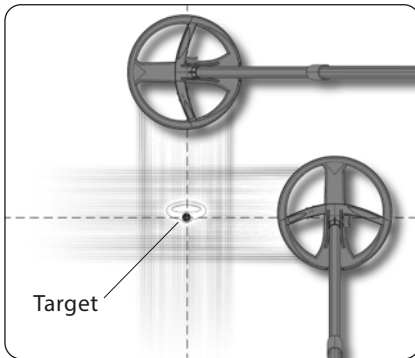

Once the detector has indicated the approximate presence of a target in Motion mode, if you are having difficulty locating the target then sweep the place where you heard the sound. Slowly reduce the amplitude of your movements and make a mental note of the spot where the sound is loudest. If necessary, indicate it with a mark on the ground. Then move a quarter turn around the spot and begin sweeping again in the same way (at 90° to the first sweep). You should then locate the precise zone containing your target at the intersection of the two sweeps, where the sound is loudest. Continue with crossed sweeps over the target. The loudest and highest pitched audio signal indicates the centre of the coil and therefore the position of the target.

PRECAUTION FOR USE

Dēus is a precision device, designed to be as robust as possible. Despite this, it is important to take care of it and exercise certain precautions in order to prolong its life:

- ⚠ Do not store your device for long periods with discharged batteries. Ideally you should discharge/recharge the batteries at least once a month, and if possible store them 40 to 70% charged.
- ⚠ Do not expose your detector to extreme temperatures, particularly inside a car in full sun.
- ⚠ Do not expose your detector to the sun without reason when it is not being used.
- ⚠ When you switch on the detector ensure that the coil is not near any metal objects.
- ⚠ The remote control of your detector is not waterproof. In wet weather be sure to protect it!
- ⚠ Use the storage case that is supplied with the headphones and never carry them at the bottom of a bag without protection.
- ⚠ Use the case that is supplied with the remote control to protect it in adverse conditions, and when the detector is stored away.
- ⚠ Do not use solvents or alcohol to clean the detector. Soapy water is sufficient.
- ⚠ Depending on how you use your detector, it may be advisable to clean its elements regularly. A damp cloth can be used to clean the non-waterproof parts (headphones and remote control).
- ⚠ After use, remove any dirt from the stem's locking mechanisms.
- ⚠ The equipment must be recharged using a SELV LPS power supply

TROUBLESHOOTING

You become aware of abnormal performance, instability, false signals, interference, for no apparent reason

CAUSES	SOLUTIONS
Sensitivity is too high.	Lower it.
You are in a zone with a lot of interference (high-voltage power lines, electric transformer, electric fence).	Lower the sensitivity change frequency/frequency shift or move to a different zone
There is a storm nearby and the electromagnetic discharges of lightning are interfering with the detector.	Switch off and wait for the storm to pass
You are close to other working metal detectors.	Change or shift the frequency (pg 22). or move further away.
The ground balance is set too low.	Reset it with Manual mode
The ground is heavily infested with iron and other metals.	Find a less infested place. Don't practice in your garden!

The coil does not switch on, unlike the WS4

CAUSES	SOLUTIONS
You have a different coil selected in the menu COIL on the WS4.	Select the corresponding coil (pg 16).
The serial number of the coil that you had entered in the WS4 was incorrect or was changed inadvertently.	Check the coil's serial number (pg 17).paying attention to D & O also B & 8.
The coil battery is discharged	Recharge it.
The coil is defective.	Contact your reseller.

There is no detection sound in the headphones despite them being switched on (and pressing the buttons generates an audible beep)

CAUSES	SOLUTIONS
Check that you do not have a different coil selected in the COIL menu (pg 16).	Select the right coil (pg 16).
The WS4 have not yet been paired with the coil.	Pair them (pg 17).
The coil's serial number was changed inadvertently in the WS4 and the WS4 is no longer paired with the coil.	Pair them (pg 17).

There is no sound in the headphones when passing over a target and pressing the buttons generates no audible beep

CAUSES	SOLUTIONS
The backphone is faulty.	Change it, it is easy to replace (pg 15).
The earpiece is faulty, for example its keypad was poorly reconnected to the circuit after being removed, or the audio contacts are faulty or dirty.	Contact your reseller

SPECIFICATIONS

Radio	Link	Digital wireless
	Channels	36 automatic channels
	Radio frequencies and Radio power	2.4 GHz / 0.56 mW
	Detection frequencies	4 - 8 - 12 - 18 - 25 kHz + shifts (X35 coils)
		15 - 30 - 50 or 80 kHz + shifts (depending HF coils)
	Sensitivity	99 levels
	Transmitter Power	3 levels (X35 coils)
	Reactivity	6 levels
	Sound Curve	8 levels
	Iron level	6 levels
	Multi tones	1, 2, 3, 4, 5, Full tones, Pitch
	Ground balance	Tracking, Pumping, Manual, Wet beach
	Mode	Motion/Semi-static (Prg 10)
	Discrimination	audio and visual
	Iron discrimination range	106 levels
Non-iron discrimination range	90 levels	
Factory programmes	x10 + 8 customizable programs	
Settings	Audio volume	Yes on wireless headphones
	Wireless headphones	Yes (can also serve as control unit), weatherproof.
	Coil	DD - 6 meters / 20 feet Waterproof - Wireless
	Coil cover	Yes
	Headphones storage case	Yes
	Stem	Fully telescopic, S-shaped
	Batteries	Lithium
	Battery level indicator	Yes
	WS4 module battery life	~ 22 hours
	WSAUDIO wireless headphone battery life	~ 12 hours
	Coil battery life	~ 15 hours depending frequency
	Mains power charger	Optional - Input 100-240V 50/60Hz, Output 5V $\overline{\text{---}}$ 1A
	Charging cable	Yes - simultaneous charging of all 3 elements via USB
	Car cigarette lighter charger	Optional
	Charging time	~ 3h00
	Total weight with batteries	~ 820 g (~ 750 g without WS4)
	Total weight of stem	~ 385 g
	Weight of headphones with battery	~ 86 g (WS4), ~ 255 g (WS5)
	Weight of coil	~ 345 g with coil cover (22.5 cm)
	Length of folded stem	58 cm
	Length of deployed stem	130 cm
	Operating T°	10°C to 40°C
	Max ambient T° during charging	10°C to 40°C
	Recommended storage T°	25°C
	Waterproof coil	Yes, but need the optional antenna for use with the coil submerged
Guarantee	5 years parts and labour. Batteries, chargers & connectors have a 2 years warranty.	
Patents	US 7940049 B2 - EP 1990658 B1	
General Features		



DEUS Remote D08 (XPIHM)



WS5 Headphone (XPBKF)



WS4 Headphone (XPBKF)



FX-03 Headphone



WSAUDIO Headphone



Coil X35 D01X35 (MDMF22)
22.5 cm - 9"



Coil X35 D28X35 (MDMF28)
28 cm - 11"



Coil X35 D3428X35 (MDMF3428)
34 x 28 cm - 13" x 11"



HF Coil D01HF (MDHF22)
22.5 cm - 9"



HF coil elliptical DELLHF (MDHF2413)
24 x 13 cm - 10" x 5"



Pinpointer MI-6 (XPMI61)



Pinpointer MI-4 (XPMI41)



MI-4 / MI-6 Stem Support



Holster



Lanyard



Hipmount case



Protective silicone case



Armband case



Kits: Waterproof armband 5 m + Aerial antenna
(available in 1m15 or 2m50)



WS4 wristband

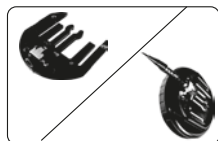

WS4 Clip jack adaptor
Connect your own
headphone



WS4 stem support



Car charger



S - TELESCOPIC LITE (D044LITE)



S-TELESCOPIC (D044)



XPBACKPACK 280



XPBACKPACK 240



XP FINDS POUCH



XP CASE



GOLD PAN STARTER



GOLD PAN PREMIUM



GOLD BATEA



GOLD SLUICE

SPARE PARTS

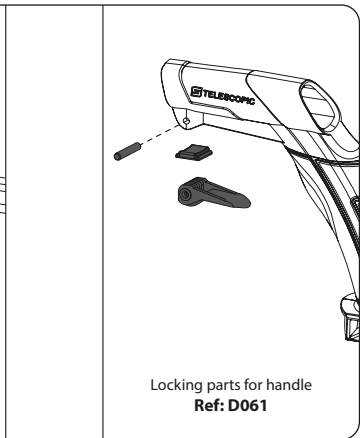
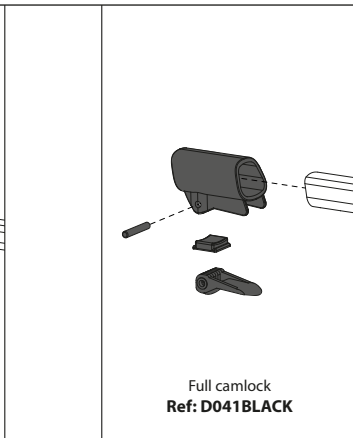
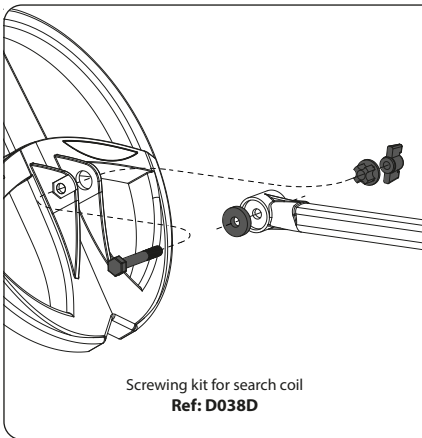
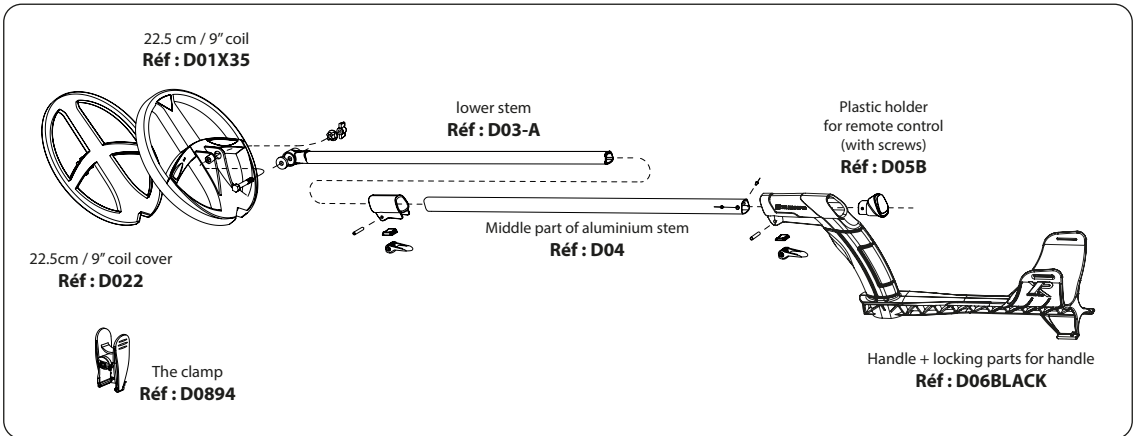

FULL WS4 - Ref: D09



WSAUDIO - Ref: WSAUDIO

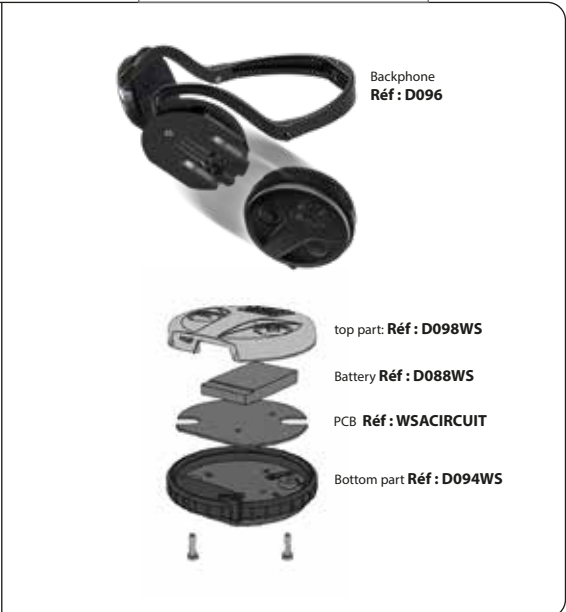

FACTORY PROGRAMS

General use

Mineralised grounds
Smalls targets

Mineralised and iron infested grounds
Smalls targets
Faster than GMPOWER

			program 1	program 2	program 3
MENU	MENU EXPERT	SETTINGS	BASIC	GM POWER	DEUS FAST
DISCRI	DISCRI (thrs 1 tone / 2 tones)	-6.4 to 99	10	6.1	6.1
	2 TONES	✓ switch on			
	3 TONES	✓ switch on	✓	✓	✓
	4 TONES	✓ switch on			
	5 TONES	✓ switch on			
	FULL TONES	✓ switch on			
	PITCH	✓ switch on			
	THRESHOLD 2T/ 3 TONES	0 to 99	76	76	76
	THRESHOLD 3T/ 4 TONES	0 to 99	84	84	84
	THRESHOLD 4T/ 5 TONES	0 to 99	92	92	92
	FREQUENCY TONE 1	100 to 993 Hz	202	202	202
	FREQUENCY TONE 2	100 to 993 Hz	518	518	518
	FREQUENCY TONE 3	100 to 993Hz	644	644	644
	FREQUENCY TONE 4	100 to 993 Hz	725	725	725
	FREQUENCY TONE 5	100 to 993 Hz	800	800	800
	FREQUENCY PITCH	150 to 603 Hz	362	362	362
SENSITIVITY		0 to 99	90	90	90
	TX POWER (DEUS)	1 to 3	2	2	2
FREQUENCY	DEPENDING COIL USED	4 to 80 kHz	12K	18K	18K
	FREQUENCY SHIFT	-3 to 3	0	0	0
IRON LEVEL		0 to 5	0	3	3
REACTIVITY		0 to 5	2	2	3
	SILENCER	-1 to 4	2	2	-1
AUDIO.R		0 to 7	4	4	4
NOTCH 1		00-00 to 99-99	00-00	00-00	00-00
	NOTCH 2	00-00 to 99-99	00-00	00-00	00-00
	NOTCH 3	00-00 to 99-99	00-00	00-00	00-00
GROUND	MANUAL	0-30 ^(beach) 60-95 ^(normal)	90	90	90
	BEACH	✓ switch on			
	TRACKING (Except beach mode)	✓ switch on			
	NOTCH GROUND	00-00 to 99-99			
THRESHOLD		0 to 20			
Discri IAR prog 10 only		0 to 5			

FACTORY PROGRAMS

General use
Audio signal
varies both in
amplitude and height

For large
masses
and highly
conductive coins

Pro setting for
locating
deep targets,
with moderate
discrimination
and specific signal
processing.

More effective
for wet sand

More effective
for dry sand

The Pro setting
based on the Full
Tone audio mode
with a very low
discrimination.

Search of gold
nuggets in highly
mineralised soil -
All Metal
program

program 4	program 5	program 6	program 7	program 8	program 9	program 10
PITCH	G-MAXX	DEEP	WET BEACH	DRY BEACH	HOT	GOLD FIELD
6.1	6.1	5.5	10	10	-6.4	IAR 0
		✓				
	✓		✓			
				✓		
					✓	
✓						✓
76	76	76	76	76	76	
84	84	84	84	84	84	
92	92	92	92	92	92	
202	202	202	202	202	202	
518	518	710	518	518	518	
644	644	644	644	644	644	
725	725	725	725	725	725	
800	800	800	800	800	800	
362	362	362	362	362	362	362
90	90	90	85	90	90	95
2	2	3	1	2	2	2
12K	8K	8K	18K	18K	18K	18K
0	0	0	0	0	0	0
3	0	3	0	0	0	
2.5	1	2	3	2	3	2
-1	2	-1	-1	4	-1	
4	4	4	1	4	3	2
00-00	00-00	00-00	00-00	00-00	00-00	
00-00	00-00	00-00	00-00	00-00	00-00	
00-00	00-00	00-00	00-00	00-00	00-00	
90	90	88	27	90	90	90
			✓			
						0
						0

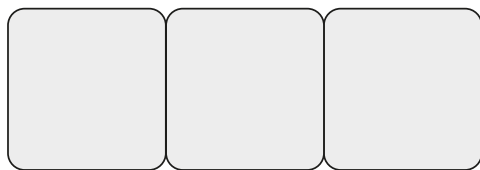

			program 11		
MENU	MENU EXPERT	SETTINGS			
DISCRI	DISCRI (thrs 1 tone / 2 tones)	- 6.4 to 99			
	2 TONES	✓ switch on			
	3 TONES	✓ switch on			
	4 TONES	✓ switch on			
	5 TONES	✓ switch on			
	FULL TONES	✓ switch on			
	PITCH	✓ switch on			
	THRESHOLD 2T/ 3 TONES	0 to 99			
	THRESHOLD 3T/ 4 TONES	0 to 99			
	THRESHOLD 4T/ 5 TONES	0 to 99			
	FREQUENCY TONE 1	100 to 993 Hz			
	FREQUENCY TONE 2	100 to 993 Hz			
	FREQUENCY TONE 3	100 to 993Hz			
	FREQUENCY TONE 4	100 to 993 Hz			
	FREQUENCY TONE 5	100 to 993 Hz			
	FREQUENCY PITCH	150 to 603 Hz			
SENSITIVITY		0 to 99			
	TX POWER (DEUS)	1 to 3			
FREQUENCY	DEPENDING COIL USED	4 to 80 kHz			
	FREQUENCY SHIFT	-1 to 1			
IRON LEVEL		0 to 5			
REACTIVITY		0 to 5			
	SILENCER	-1 to 4			
AUDIO.R		0 to 7			
NOTCH 1		00-00 to 99-99			
	NOTCH 2	00-00 to 99-99			
	NOTCH 3	00-00 to 99-99			
GROUND	MANUAL	0-30 ^(beach) 60-95 ^(normal)			
	BEACH	✓ switch on			
	TRACKING (Except beach mode)	✓ switch on			
	NOTCH GROUND	00-00 to 99-99			
THRESHOLD		0 to 20			
DiscrI IAR (prog 10 only)		0 to 5			

Detecting is an activity which, like other leisure activities, requires a few general guidelines. These recommendations will enable everyone to enjoy their hobby to the full while respecting laws, places, the environment and other people.

- Ensure you are informed of current legislation relating to discovery of treasure in order to abide by the law.
- Declare any fortuitous archaeological discoveries to the local authorities (town hall) of the discovery site within 48 hours.
- Before prospecting on a site, obtain permission from its owner(s) or guardian(s).
- Respect the natural environment in which you are prospecting and any other places to which you need access.
- Systematically back-fill any holes you make so as to leave a site exactly how you found it.
- Keep any rubbish you find in order to dispose of it in a dustbin.

Avoid detecting in areas where battles are known to have taken place during wartime. Exercise extreme caution with any suspect object resembling munitions, grenades, mines, shells, bombs, etc. and notify the relevant authorities (police, local authorities, etc.) of any such object you find.

Remember that you are an ambassador for metal detecting and it is important that you convey a positive image!

DECLARATION OF CONFORMITY EU



This declaration is made under the responsibility of the manufacturer:

XPLORER SARL - 8 rue du Développement – F-31320 CASTANET-TOLOSAN

We, XPLORER, hereby certify that this detector complies with the essential requirements of European Directives RED 2014/53/EU, SECURITY 2014/35/EU, EMC 2014/30/EU, which aims to harmonise legislation in member states on the use of the radio spectrum, electromagnetic compatibility and electrical safety. Assessment of the device's compliance was carried out in accordance with the essential requirements of this directive and the harmonised standards:

- **SECURITY (art 3.1.a)** : IEC 62368-1:2014+A11 :2017 ; IEC 609501:2005(2ndEd) +Am1:2009+Am2:2013
- **EMC (art 3.1.b)** : ETSI EN 301 489-3 : 2013 v1.6.1 ; ETSI EN 301 489-1 : 2013 v1.9.2
- **RADIO SPECTRUM (art 3. 2)** : EN 300 440-2 v1.4.1 ; EN 300 440-1 v1.6.1 ; AS/NZS 4265:2012 ; EN303454[4.1-3]

Declaration date : 06.01.2021

For more information please contact:

XPLORER SARL - 8 rue du Développement – F-31320 CASTANET-TOLOSAN - FRANCE

CERTIFICATION FCC



This device complies with part 15 of the FCC Rules. Operation is subject to the following two conditions:

- (1) This device may not cause harmful interference, and
- (2) This device must accept any interference received, including interference that may cause undesired operation.

NOTE: The grantee is not responsible for any changes or modifications not expressly approved by the party responsible for compliance. Such modifications could void the user's authority to operate the equipment

IC This device contains licence-exempt transmitter(s)/receiver(s) that comply with Innovation, Science and Economic Development Canada's licence-exempt RSS(s). Operation is subject to the following two conditions:

- (1) This device may not cause interference.
- (2) This device must accept any interference, including interference that may cause undesired operation of the device.

L'émetteur/récepteur exempt de licence contenu dans le présent appareil est conforme aux CNR d'Innovation, Sciences et Développement économique Canada applicables aux appareils radio exempts de licence. L'exploitation est autorisée aux deux conditions suivantes :

- 1) L'appareil ne doit pas produire de brouillage;
- 2) L'appareil doit accepter tout brouillage radioélectrique subi, même si le brouillage est susceptible d'en compromettre le fonctionnement.

Safety relating to electromagnetic radio waves

This product complies with standards for user safety with regard to electromagnetic waves. The strength of the radio signals used is considerably weaker and on a much smaller scale than those emitted by mobile telephones (2,000 to 4,000 times weaker), as well as being much less than those used by Wi-Fi systems.

Moreover, when the complete system is used, the audio headphones only act as a passive radio receiver.

Recycling of electrical and electronic waste in the European Union and the other countries / regions in accordance with selective waste sorting procedures



If this symbol is displayed on the product or its packaging, it means that the product must not be disposed of with your household waste. You must take it to a designated collection point for recycling electrical and electronic waste. This selective waste sorting and recycling helps to preserve natural resources and avoid any potential risks for human health and the environment that could result from inappropriate scrapping, due to the possible presence of dangerous substances in the electric and electronic equipment. For more information on places where you can take your electrical waste, please contact the shop where you purchased this product. Alternatively you can return it to your supplier, or directly to **XP**. The same is true for the lithium batteries which must be recycled appropriately.

WARNING

The accessories delivered with these detectors may vary, and similarly the menus and certain features described in this manual may differ slightly from the product purchased.

This detector is not suitable for applications involving the search for dangerous targets such as munitions, mines, etc.

© 2018 Xplorer sarl

This document contains information that is protected by existing legislation on copyright, brands and royalties.

Any reproduction, even partial, of this document, the logos or the XP and Dêus brands is prohibited without the agreement of:

XP DEUS - 5 YEARS LIMITED WARRANTY

- XP warrants that its products DEUS will be free from defects in materials or workmanship for 5 years.
- This contractual warranty for parts and labour takes effect from the initial date of purchase.

This warranty does not cover:

- Breakage caused by falls, impacts or accidental damage
- Damage caused by abnormal use or resulting from non-compliance with the conditions of use stipulated in the device's instructions
- Alteration of the electronic circuit by any unauthorized person.
- Using without coil cover, or using defective coil cover
- Corrosion of electronic circuits, due to water ingress
- A reduction in battery life due to battery ageing.
- Breakage of cables or wires

Spare parts are not cover by the 5 years warranty:

- Parts that are subject to normal wear and tear like: headphones earpads, coil bolts & fittings, cases etc... (These parts must be replaced in case of wear and tear, in such a way that no damage will be caused to the device).
- Batteries, chargers & connectors have a 2 years warranty.

In the event of any fault or malfunction please contact your XP dealer for advice, should any part require returning to them or the distributor it must be accompanied by a note explaining the fault, carriage/shipping cost is the customer's responsibility. Proof of Purchase is required to make a claim under this warranty. If a faulty device has been replaced by a new or reconditioned one, the warranty will continue from the original purchase date.

Contacts

Website : www.xpmetaldetectors.com

e-mail : contact@xpmetaldetectors-media.com

XPLORER sarl
 8 rue du développement
 F-31320 CASTANET TOLOSAN
 France

XP and Dēus are trademarks of Xplorer sarl.

Xplorer reserves the right to modify its detectors' characteristics or specifications without notice.

BATTERY SPECIFICATIONS FOR AIR TRANSPORT

TRANSPORTING LITHIUM BATTERIES: Following strict regulations regarding transportation of lithium batteries, some airlines will ask you these specifications:

	Quantity	Type	Power	battery weight
Coil DEUS	1	700mA	2.60 watts/hour	12.0 g
HF COIL	1	850mA	3.14 watts/hour	25.0 g
WS4/WS5	1	700mA	2.60 watts/hour	12.0 g
WSAUDIO headphone	1	365mA	1.35 watts/hour	6.9 g

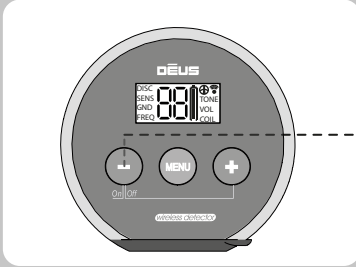



Switch on the WS4
(after extending stems and holding the coil
away from the ground and any metal)



You're now ready for detecting!

By default you begin by using the 1 - BASIC factory program which is suitable for general use.

If you wish to test one of the 10 other factory programs,

simply scroll through them with  

To switch off Dèus

Press left and right buttons   on the WS4.

If you wish to change the main detection settings:



Press Menu



Set with - / +

